

CATTLE PANEL TRELLIS Installation

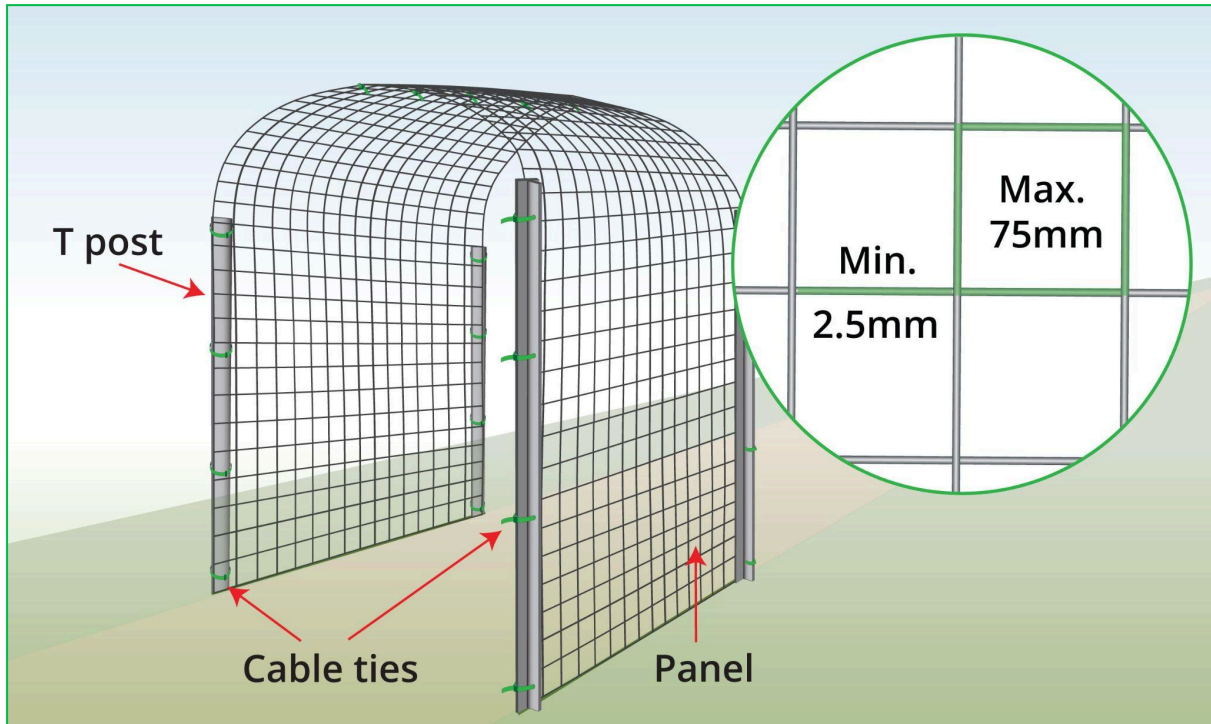
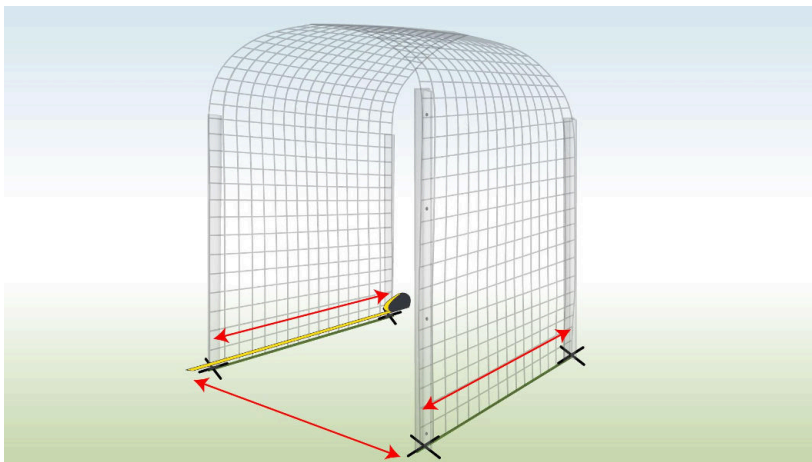

THINGS YOU'LL NEED

- Panels
- T posts
- Cable ties
- Post driver
- Level
- Tape measure

INSTRUCTIONS**Step 1: Measure Area & Mark Post Locations**

Measure your area and mark your post locations according to your plan.

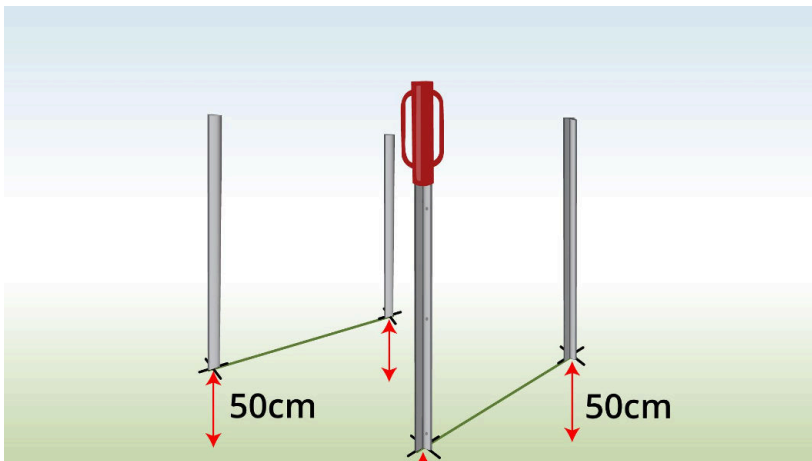
**Step 2: Install the Posts**

Drive your T posts at least 50cm into the ground, making sure the flat side of each post is facing inward.

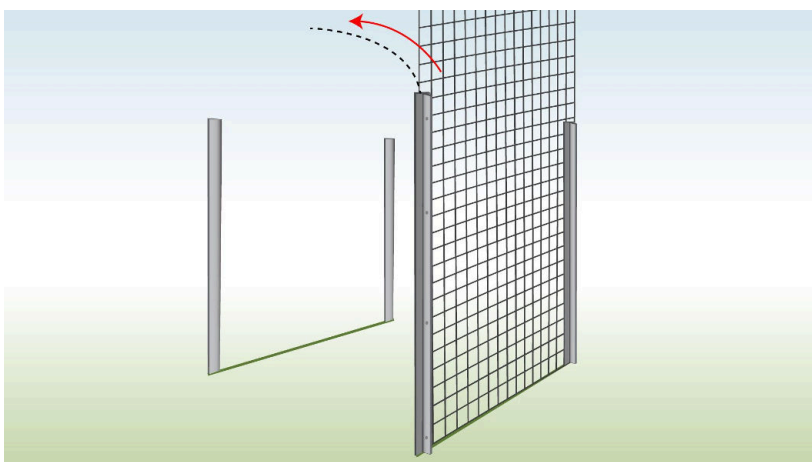
**Step 3: Bend Panel**

Position one of the panels and bend the top to create an archway.

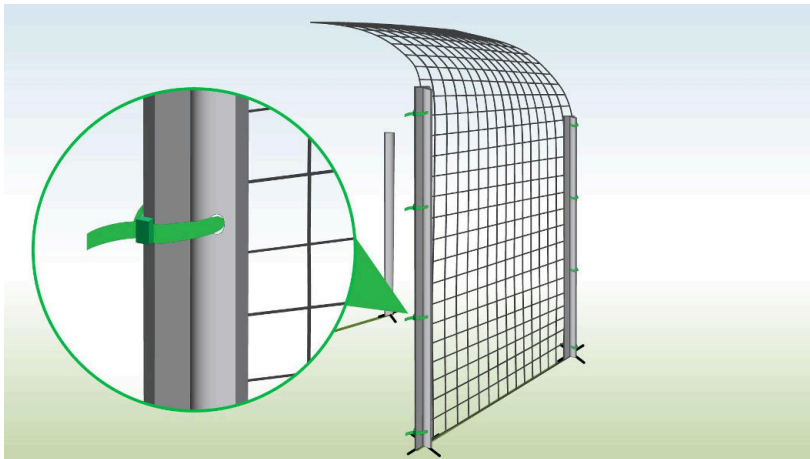

Step 4: Secure Panel

Secure it to the posts using cable ties through the pre-drilled holes.

Ensure the panel sits against the flat side of the post.

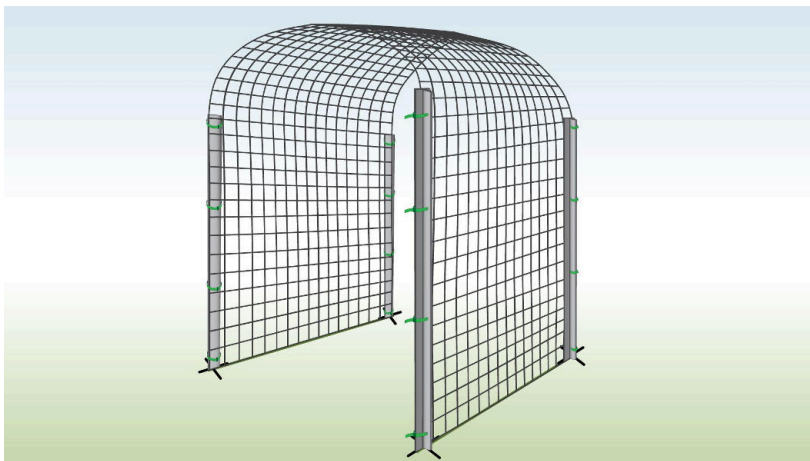

Step 5: Position the Second Panel

Position and secure the second panel, repeating the same process.

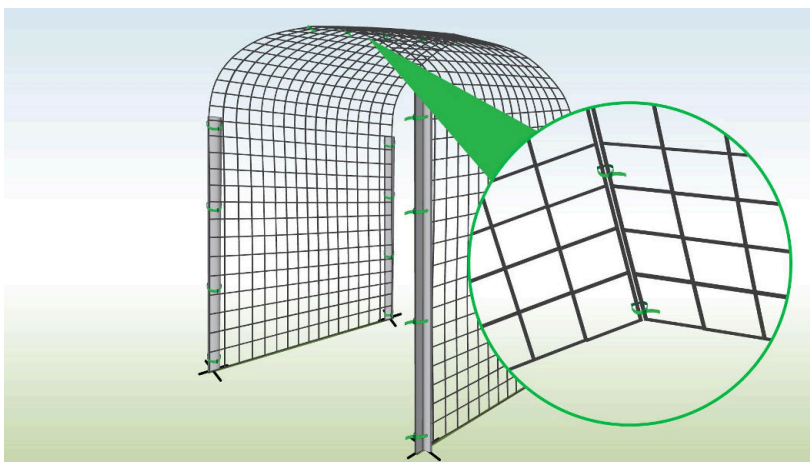

Step 6: Attach Them Together at the Top

Attach the panels together at the top using cable ties.

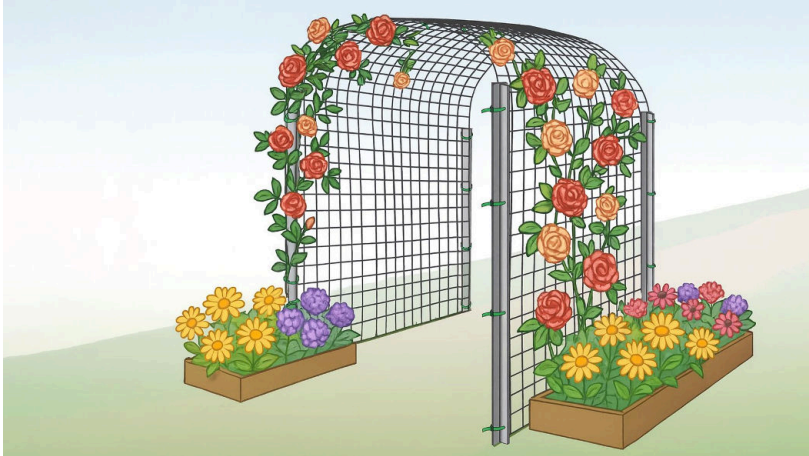

Step 7: Start Planting

You can now decorate the base with mulch or start training climbing plants up your new trellis.

