

CHICKEN WIRE INSTALLATION With T-Posts

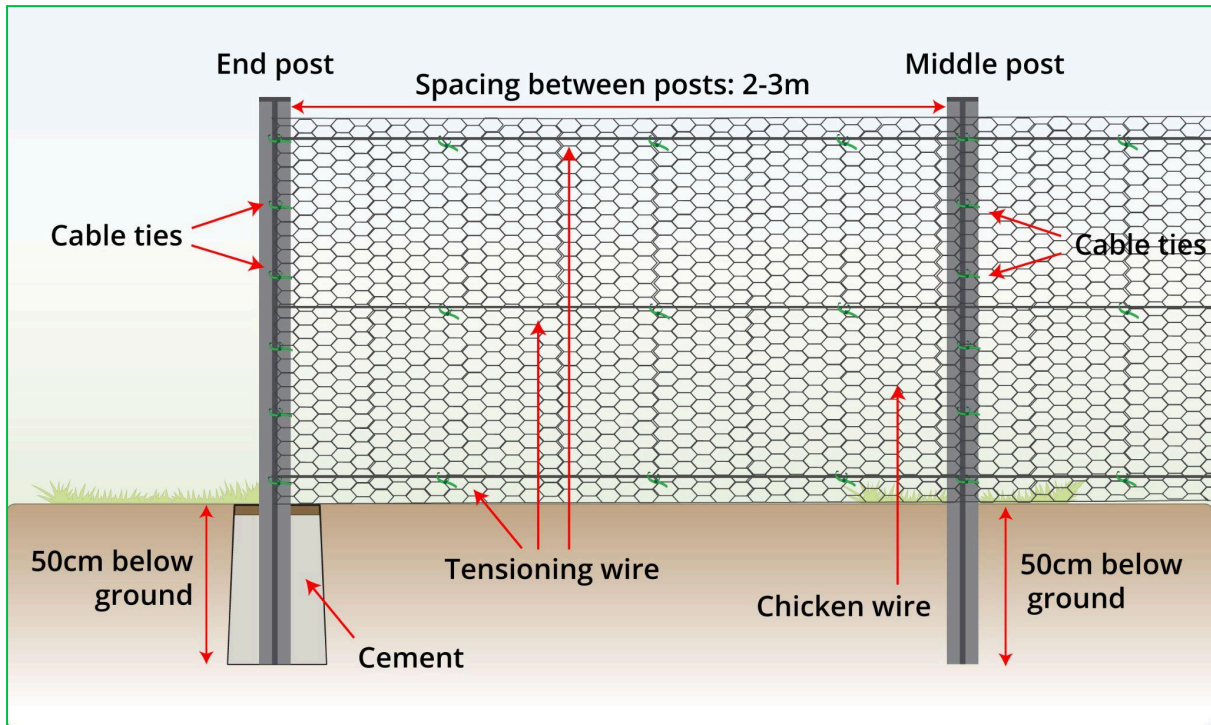
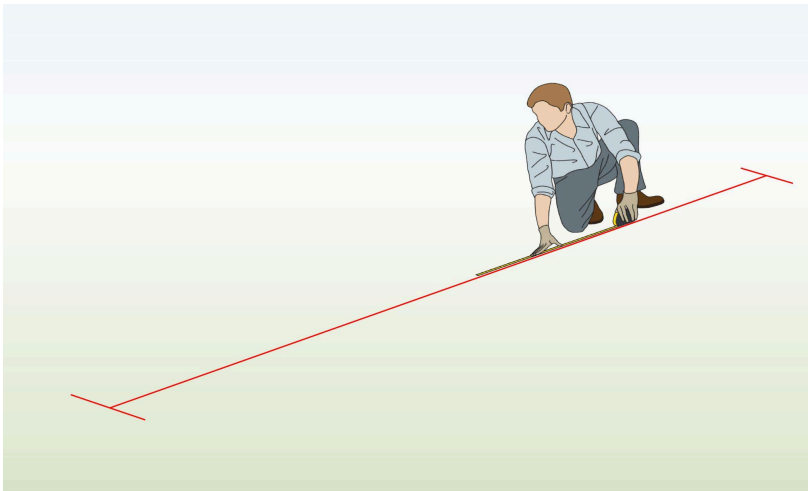

THINGS YOU'LL NEED

- Chicken wire
- T Posts
- Tape measure
- Post driver or mallet
- Cable ties
- Spirit level
- String
- Pegs
- Tensioning wire (optional)
- Plier (optional)
- Spade
- Cement (optional)

INSTRUCTIONS**Step 1: Mark Area**

Create a straight line to mark the fence between the two end posts.

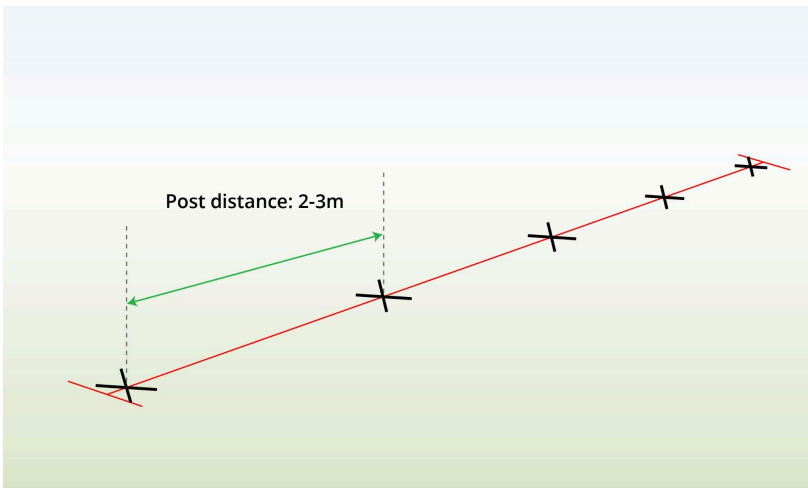
**Step 2: Measure Post Distance**

Specify the post locations 2 -3m apart by using a tape measure.

For increased stability, reduce the spacing between your fence posts.

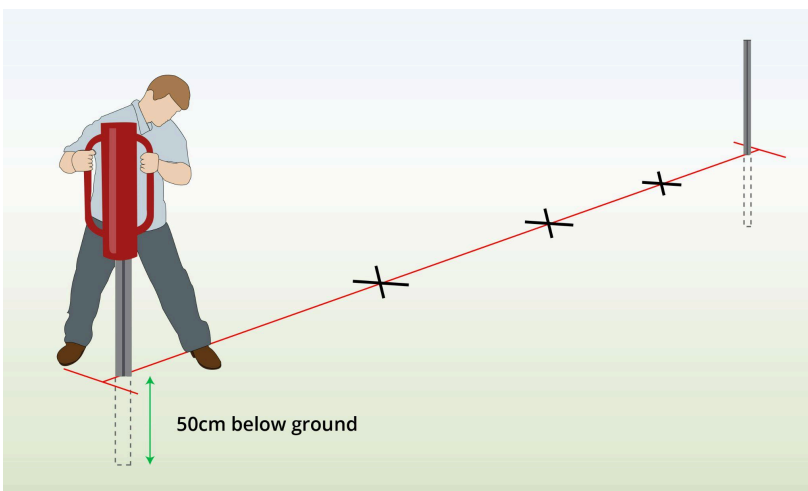
**Step 3: Install End Posts**

Use a post driver or mallet to sink the end posts 50cm into the ground.

To maintain consistent alignment, make sure the holes of the posts are oriented towards each other.

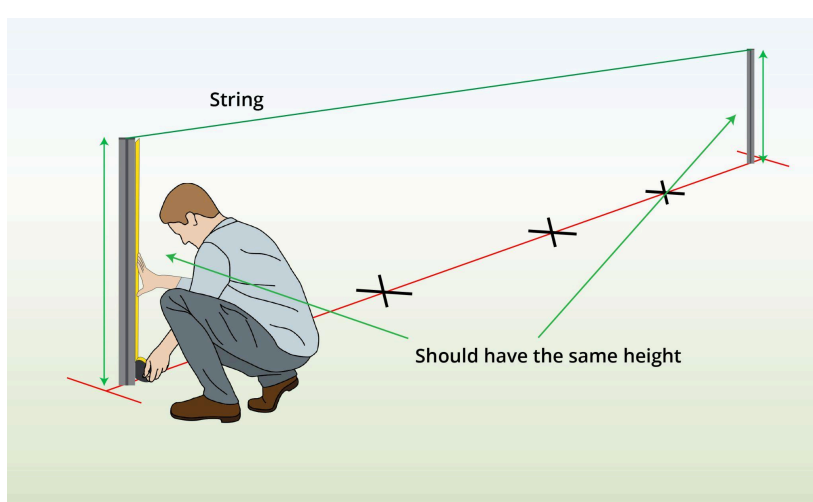

Step 4: Check for Same Height

Secure a length of string between the end posts, and then verify that they have been installed at the same height by employing a tape measure.

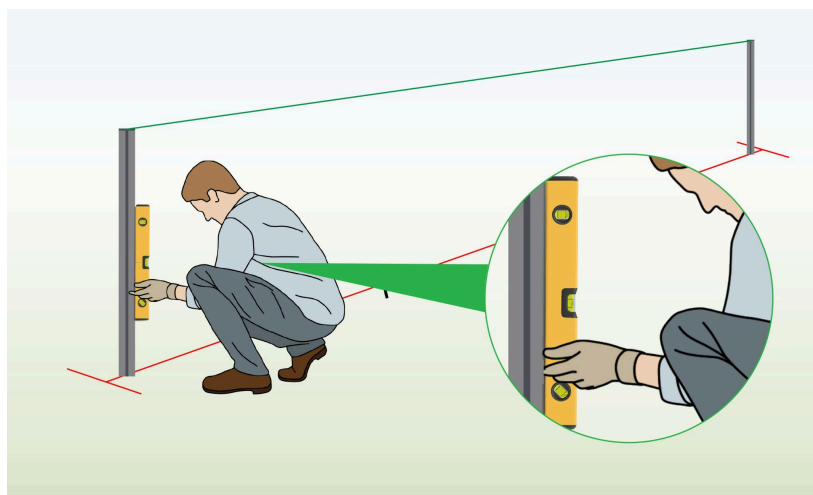

Step 5: Check for Straightness

Utilise a spirit level to confirm that the posts have been set up perfectly straight.

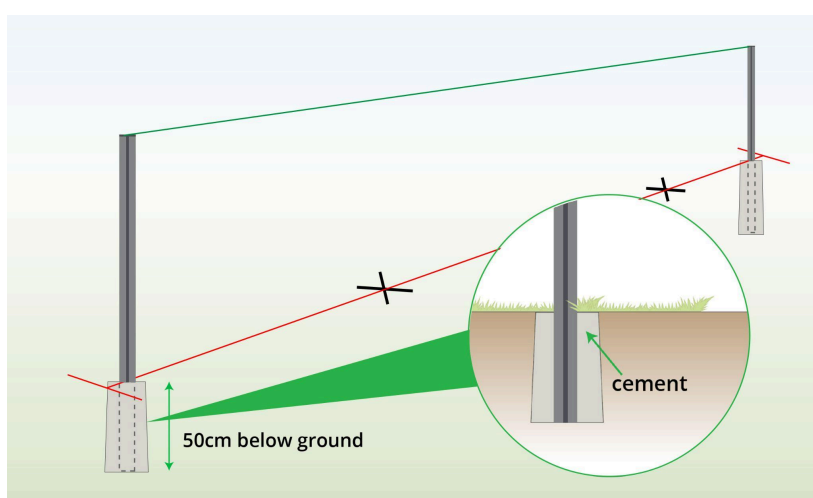

Step 6 (Optional): Set in Concrete

For a stronger and more secure fence, anchor your posts in concrete. This involves digging a 50cm hole and pouring cement to provide a sturdy foundation for the posts.

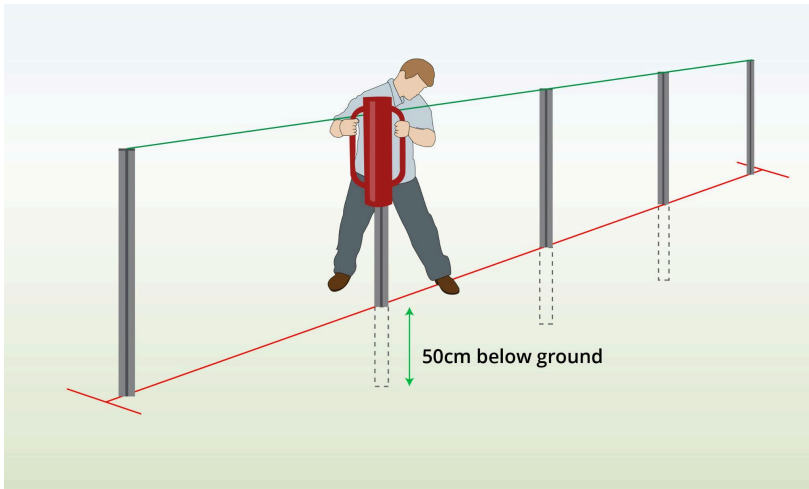

Step 7: Install Middle Posts

For the installation of middle posts, repeat steps 3-6.

Ensure that the posts are oriented in the same direction and have been set up in a consistent manner, being both straight and at the same height.

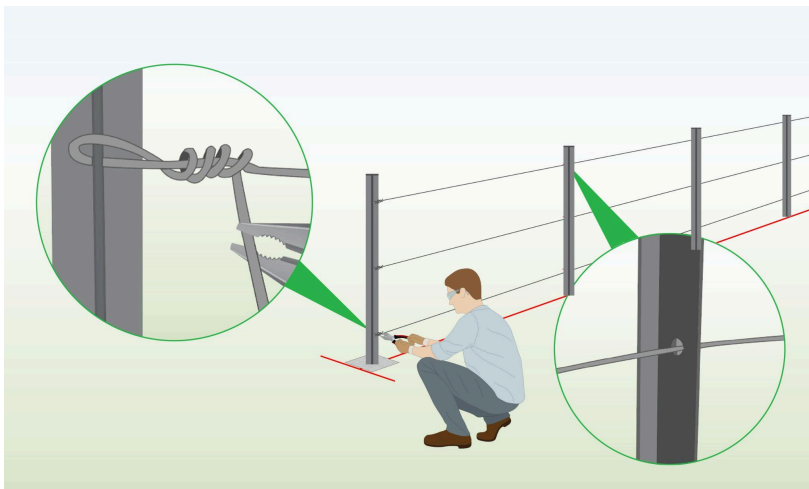

Step 9 (Optional): Install Tension Wire

When using lightweight mesh, it's advisable to secure a tension wire between the end posts to prevent any sagging.

Wrap the tension wire around the end posts' hole and fasten it by twisting the wire's end with pliers.

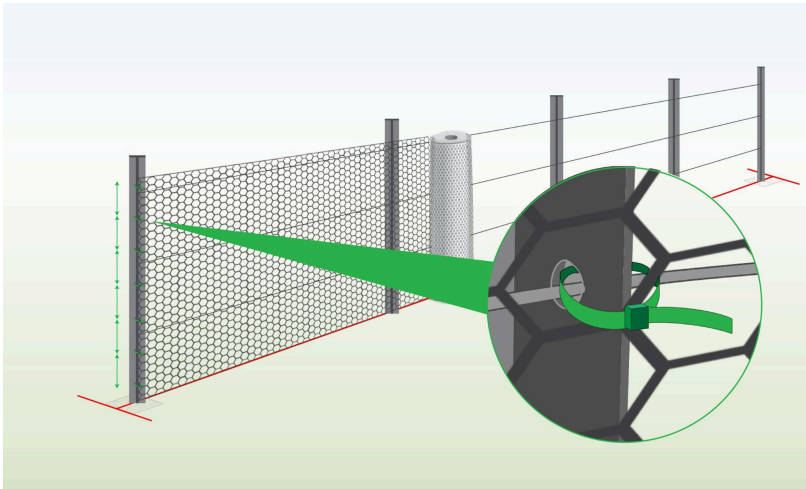

Step 10: Attach Mesh to End Post

Fasten the mesh to the end post by employing cable ties, which can be threaded through the post's pre-drilled holes.

You can increase the number of cable ties to encircle the entire post.

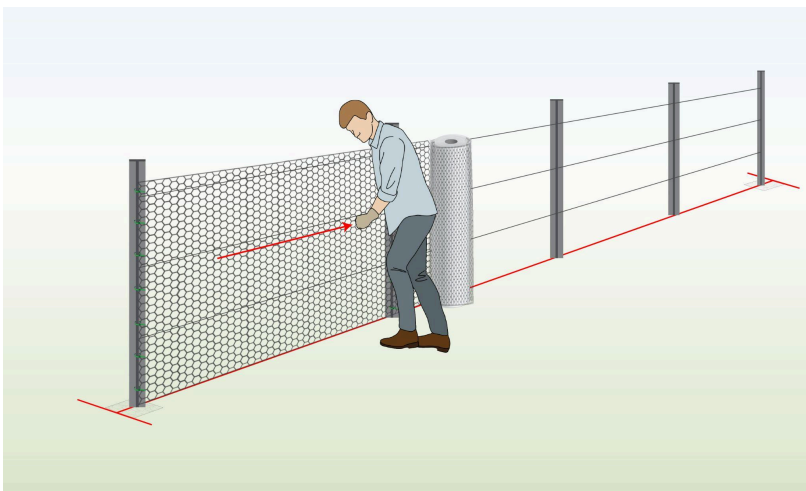

Step 11: Pull Tight

Stretch the mesh firmly and then fasten it to the second post using cable ties. Be cautious not to pull it excessively tight.

Continue with this procedure until you reach the final end post.

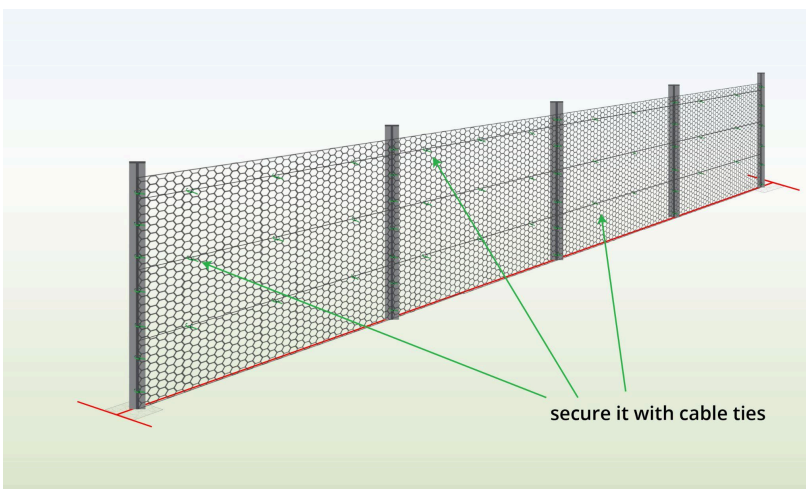

Step 12 (Optional): Attach to Tension Wire

If you've installed a tension wire, fasten the mesh to it using cable ties, leaving approximately 30-45cm gaps between them.

