

Cat-proof your fence in 5 steps

Adding a canopy overhang to the top of your existing fence, is a simple and effective way to stop your cat getting into your neighbour's garden, or worse – ending up on busy roads.

It works because the canopy is made from high tensile, flexi cat enclosure netting, angled upwards and inwards, towards your property.

For cats, this proves to be an unstable, unpleasant and difficult climb.

Benefits Recap:

- Gives your cat/s the continued freedom to access your garden
- Excellent news for cats who are already used to roaming around their garden and may struggle to adapt to a cat enclosure
- It doesn't take up any additional space – especially useful if your garden is small or tight on space already
- Often a cheaper alternative to building a full cat enclosure
- Best of all – you don't need to be a DIY super star!

In short, it's a cost effective, great way to keep your cat safe and happy, at the same time 😊

Covered in this short guide:

1. What you need to get started – tools and materials
2. Measuring up
3. Installation

1. What you need to get started – tools and materials

Materials

- [Cat Enclosure Netting](#) – comes in 1m x 100m and 2m x 200m rolls
- Steel bar cut into 1m – 1.2 metre lengths (you could also use wooden dowels drilled into the fence post at a 35°- 45° angle, or metal brackets bent to create the same angle)
- Pipe clamps (to secure the steel bar to the fence posts)
- Cable ties and/or galvanised tying wire – to secure the netting to the supports
- Screws
- Rawl plugs (depending on surface)

Recommended Tools

- Drill
- Still pipe tubing cutter or hacksaw (optional)
- Pliers
- Hammer
- Tape measure
- Scissors (to cut the netting and tidy up any cable ties)
- Wire cutters (if using galvanised tying wire)
- Staple gun

2. Measuring up

Fence height:

- To be most effective, you're aiming for a total fence height, with canopy attached, of 170cm/6ft or over.

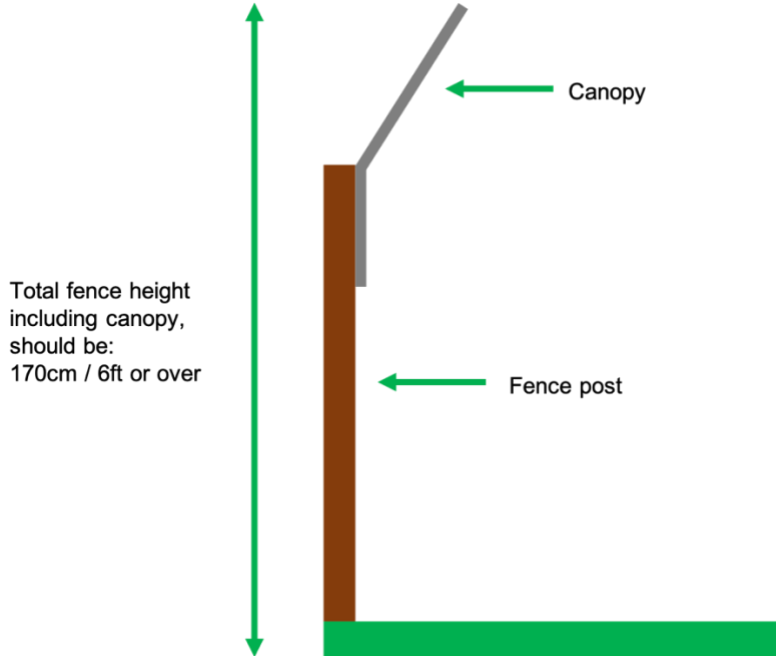

Enclosure netting:

- Measure the total length of your fence – this is how much enclosure netting you need
- Don't forget, it may also need to cover the top of any gates and go around a shed
- You may also want to include a little extra length for contingency

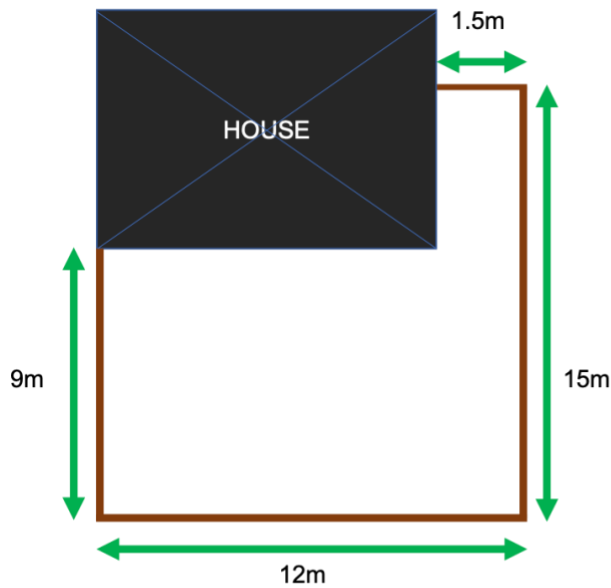

Total Fence = 37.5m
Total Enclosure Netting = 37.5m

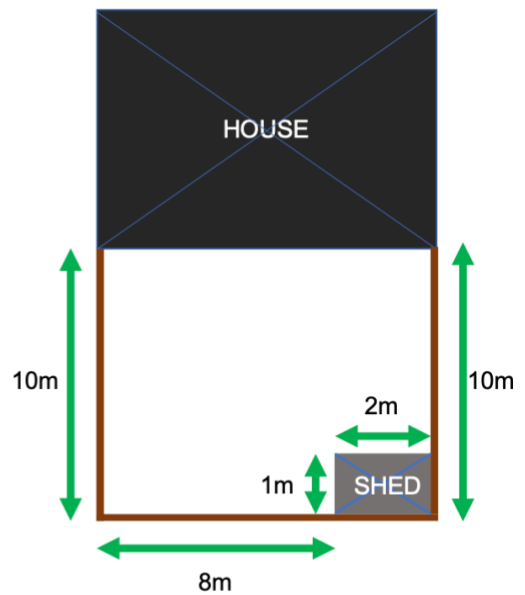

Total Fence incl. Shed = 31m
Total Enclosure Netting = 31m

Angled supports:

- A series of angled supports will hold the netting in position around the perimeter of your fence
- As a guide, you will need the same number of angled supports as you have fence posts. (So, if there are 15 posts, make sure you have at least 15 supports)
- If you have a shed, you will need a support on each corner that the netting needs to go around

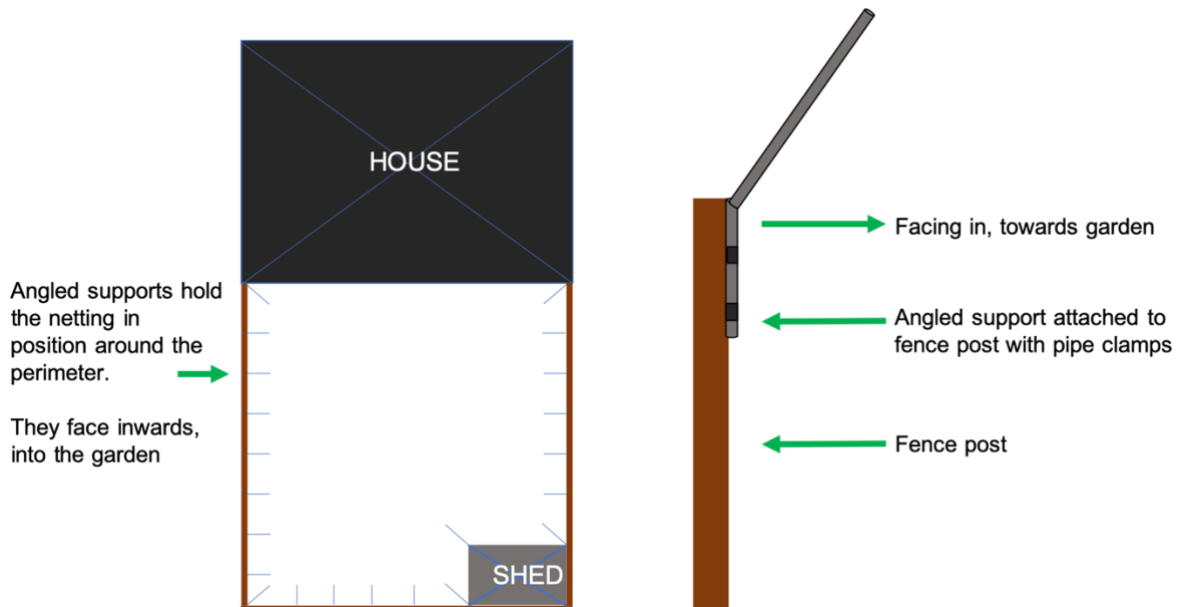

3. Installation

Step 1 – Make the fence good

- Check your fence for existing gaps or potential escape routes and close them off.

Step 2 – Angled supports

- Cut the steel bar into 1m – 1.2m long pieces – one for each fence post
- Then make a 35° - 45° angle bend in each piece, starting 30cm from the end of each bar (if you can't do this yourself, try a local metal works or lumber yard)

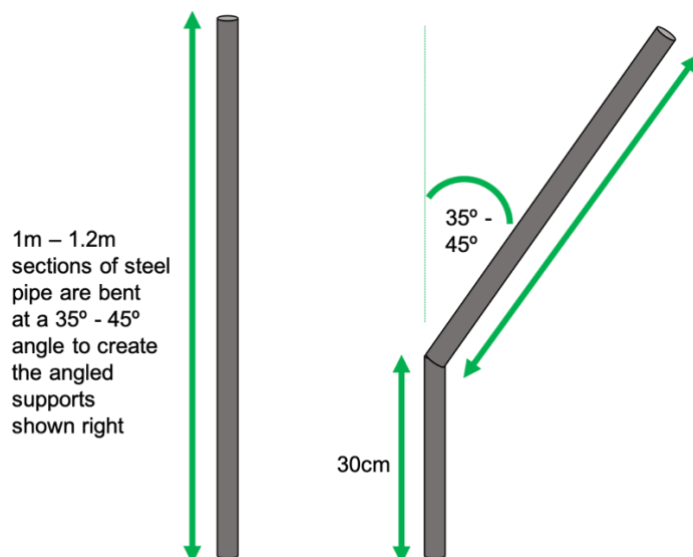

Step 3 – Attaching the supports to your fence posts

- Secure one steel bar to a fence post using 2-3 pipe clamps
- Align the bend in the pipe with the top of the fence so that the angled section of the bar is facing upwards and inwards, towards your garden
- Repeat for all fence posts and bars

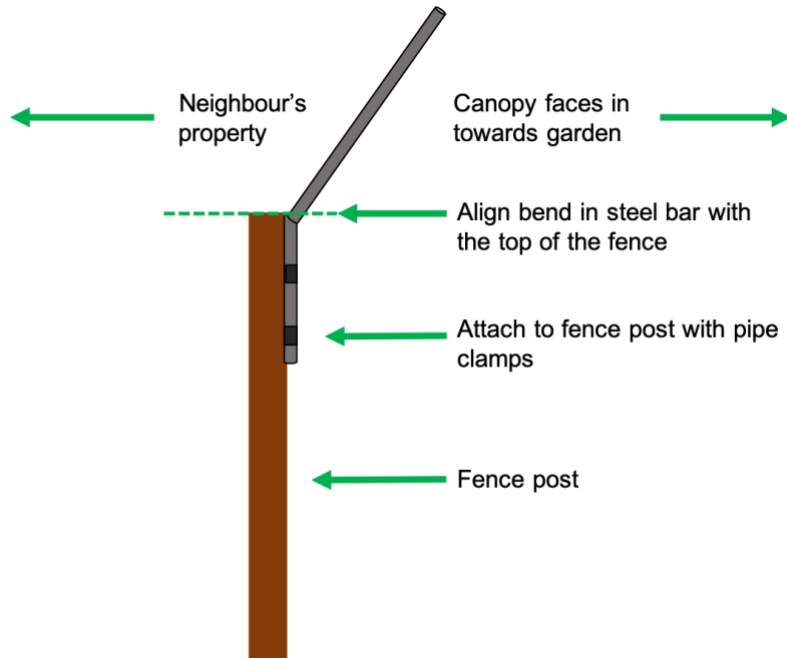

Step 4 – Adding the enclosure netting

- Attach the netting to the underside of each bar with cable ties or galvanised wire
- Leave an overhang of 30cm at the bottom of the netting

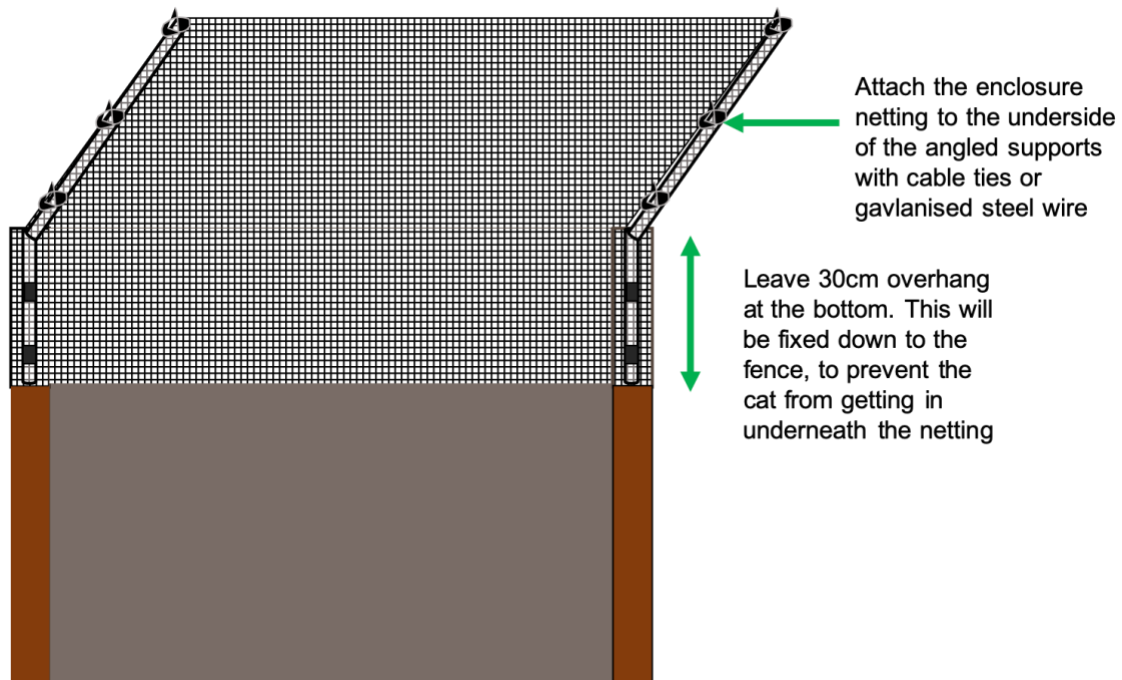

Step 5 – Final touches

- For additional support, you can weave galvanised tying wire through the mesh on both the upper and lower edges of the netting
- Tie off the wire on the upper edge of the netting, to the corner fence posts
- Staple the bottom galvanised wire edge to the fence. Avoid leaving any gaps big enough for a cat to crawl under

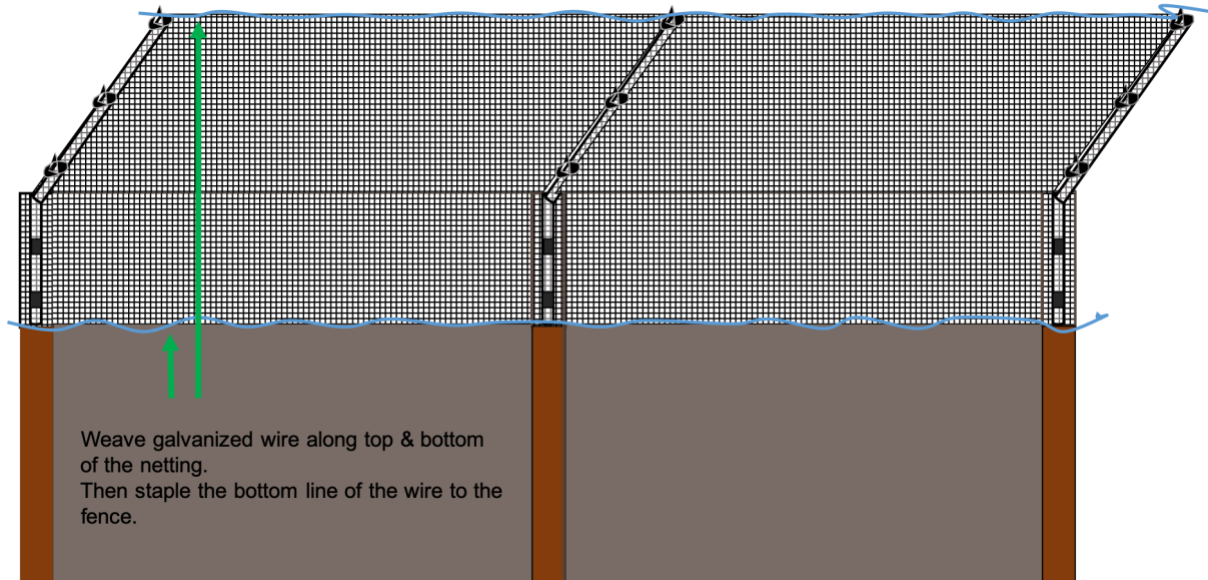

NOTE: If you're not using galvanised tying wire, staple the bottom of the netting directly to the fence.

Thanks for reading our guide on how to cat-proof your fence in 5 steps.
We hope you found it useful!

For more info on our cat enclosure netting, or any other product, please get in touch:

Email us: info@wirefence.co.uk

Talk to us: on 0330 124 3556

Visit us at: www.wirefence.co.uk